

EX-S SERIES RANGE

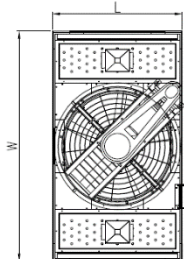

PLAN VIEW

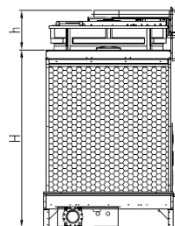

FRONT VIEW

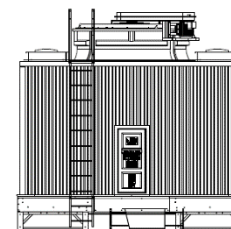

SIDE VIEW

Tower Model	Motor	Fan Diameter mm	Overall Dimension (mm)				Piping Dimension (mm)					
	kW		L	W	H	h	External Piping	Internal Piping	Water Outlet	Overflow	Drain	Make-up Auto & Manual
EXS 0707X	1.5	2000	2316	4240	2918	650	100	125	125	50	50	25
EXS 0707Y	2.2	2000	2316	4240	2918	650	100	125	125	50	50	25
EXS 0707Z	3	2000	2316	4240	2918	650	100	125	125	50	50	25
EXS 0707A	4	2000	2316	4240	2918	650	100	125	125	50	50	25
EXS 0707B	5.5	2000	2316	4240	2918	650	125	125	150	50	50	25
EXS 0707C	7.5	2000	2316	4240	2918	650	125	150	200	50	50	50
EXS 0707D	11	2000	2316	4240	2918	650	125	150	200	50	50	50
EXS 0707E	15	2000	2316	4240	2918	650	125	150	200	50	50	50
EXS 0709X	1.5	2000	2316	4240	3528	650	100	125	125	50	50	25
EXS 0709Y	2.2	2000	2316	4240	3528	650	100	125	125	50	50	25
EXS 0709Z	3	2000	2316	4240	3528	650	100	125	125	50	50	25
EXS 0709A	4	2000	2316	4240	3528	650	100	125	125	50	50	25
EXS 0709B	5.5	2000	2316	4240	3528	650	125	125	150	50	50	25
EXS 0709C	7.5	2000	2316	4240	3528	650	125	150	200	50	50	50
EXS 0709D	11	2000	2316	4240	3528	650	125	150	200	50	50	50
EXS 0709E	15	2000	2316	4240	3528	650	125	150	200	50	50	50
EXS 0711X	1.5	2000	2316	4240	4138	650	100	125	125	50	50	25
EXS 0711Y	2.2	2000	2316	4240	4138	650	100	125	125	50	50	25
EXS 0711Z	3	2000	2316	4240	4138	650	100	125	125	50	50	25
EXS 0711A	4.0	2000	2316	4240	4138	650	125	125	150	50	50	25
EXS 0711B	5.5	2000	2316	4240	4138	650	125	150	200	50	50	50
EXS 0711C	7.5	2000	2316	4240	4138	650	125	150	200	50	50	50
EXS 0711D	11	2000	2316	4240	4138	650	125	150	200	50	50	50
EXS 0711E	15	2000	2316	4240	4138	650	125	200	200	50	50	50

EX-S SERIES RANGE

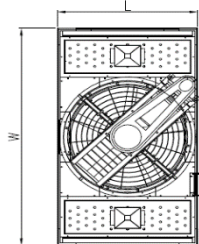

PLAN VIEW

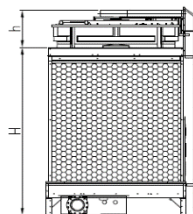

FRONT VIEW

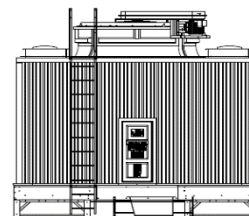

SIDE VIEW

Tower Model	Motor kW	Fan Diameter mm	Overall Dimension (mm)				Piping Dimension (mm)					
							External Piping	Internal Piping	Water Outlet	Overflow	Drain	Make-up Auto & Manual
			L	W	H	h						
0807X	1.5	2135	2590	4550	2918	650	100	125	125	50	50	25
0807Y	2.2	2135	2590	4550	2918	650	100	125	125	50	50	25
0807Z	3	2135	2590	4550	2918	650	100	125	125	50	50	25
0807A	4	2135	2590	4550	2918	650	125	125	150	50	50	25
0807B	5.5	2135	2590	4550	2918	650	125	125	150	50	50	25
0807C	7.5	2135	2590	4550	2918	650	125	150	200	50	50	50
0807D	11	2135	2590	4550	2918	650	125	150	200	50	50	50
0807E	11	2135	2590	4550	2918	650	125	200	200	50	50	50
0807F	15	2135	2590	4550	2918	650	150	200	200	50	50	50
0809X	1.5	2135	2590	4550	3528	650	100	125	125	50	50	25
0809Y	2.2	2135	2590	4550	3528	650	100	125	125	50	50	25
0809Z	3	2135	2590	4550	3528	650	100	125	125	50	50	25
0809A	4	2135	2590	4550	3528	650	125	150	200	50	50	50
0809B	5.5	2135	2590	4550	3528	650	125	150	200	50	50	50
0809C	7.5	2135	2590	4550	3528	650	125	150	200	50	50	50
0809D	11	2135	2590	4550	3528	650	125	200	200	50	50	50
0809E	15	2135	2590	4550	3528	650	150	200	200	50	50	50
0809F	18.5	2135	2590	4550	3528	650	150	200	200	50	50	50
0811X	1.5	2135	2590	4550	4138	650	100	125	125	50	50	25
0811Y	2.2	2135	2590	4550	4138	650	100	125	125	50	50	25
0811Z	3	2135	2590	4550	4138	650	100	125	125	50	50	25
0811A	4	2135	2590	4550	4138	650	125	125	150	50	50	25
0811B	5.5	2135	2590	4550	4138	650	125	150	200	50	50	50
0811C	7.5	2135	2590	4550	4138	650	125	150	200	50	50	50
0811D	11	2135	2590	4550	4138	650	125	200	200	50	50	50
0811E	15	2135	2590	4550	4138	650	150	200	200	50	50	50
0811F	18.5	2135	2590	4550	4138	650	150	200	200	50	50	50

EX-S SERIES RANGE

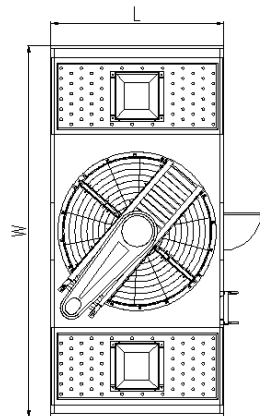

PLAN VIEW

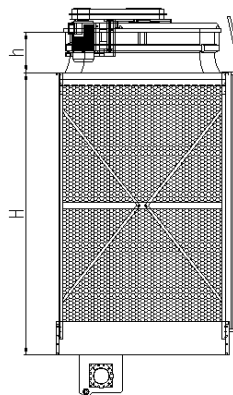

SIDE VIEW

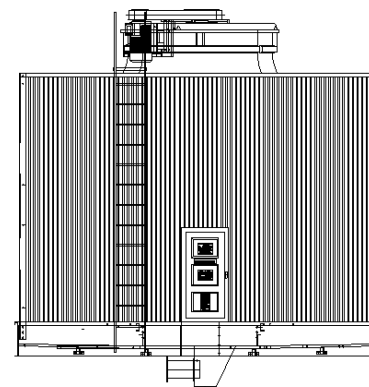

FRONT VIEW

Tower Model	Motor	Fan Diameter	Overall Dimension (mm)				Piping Dimension (mm)					
	kW	mm	L	W	H	h	External Piping	Internal Piping	Water Outlet	Overflow	Drain	Make Up Auto & Manual
EXS 0810Y	1.5	2135	2590	5550	3605	650	125	200	250	50	50	50
EXS 0810Z	2.2	2135	2590	5550	3605	650	125	200	250	50	50	50
EXS 0810Z	3	2135	2590	5550	3605	650	125	200	250	50	50	50
EXS 0810A	4	2135	2590	5550	3605	650	125	200	250	50	50	50
EXS 0810B	5.5	2135	2590	5550	3605	650	125	200	250	50	50	50
EXS 0810C	7.5	2135	2590	5550	3605	650	125	200	250	50	50	50
EXS 0810D	11	2135	2590	5550	3605	650	125	200	250	50	50	50
EXS 0810E	15	2135	2590	5550	3605	650	125	200	250	50	50	50
EXS 0810F	18.5	2135	2590	5550	3605	650	125	200	250	50	50	50
EXS 0812Y	1.5	2135	2590	5550	4215	650	125	200	250	50	50	50
EXS 0812Z	2.2	2135	2590	5550	4215	650	125	200	250	50	50	50
EXS 0812Z	3	2135	2590	5550	4215	650	125	200	250	50	50	50
EXS 0812A	4	2135	2590	5550	4215	650	125	200	250	50	50	50
EXS 0812B	5.5	2135	2590	5550	4215	650	125	200	250	50	50	50
EXS 0812C	7.5	2135	2590	5550	4215	650	125	200	250	50	50	50
EXS 0812D	11	2135	2590	5550	4215	650	125	200	250	50	50	50
EXS 0812E	15	2135	2590	5550	4215	650	125	200	250	50	50	50
EXS 0812F	18.5	2135	2590	5550	4215	650	125	200	250	50	50	50

EX-S SERIES RANGE

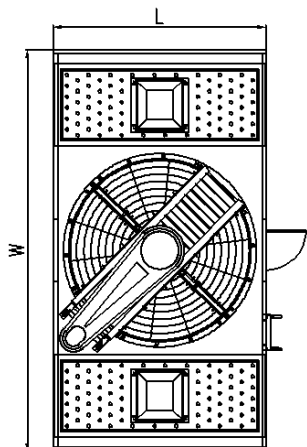

PLAN VIEW

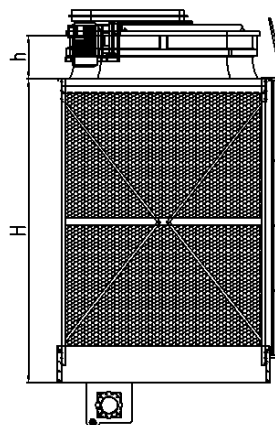

SIDE VIEW

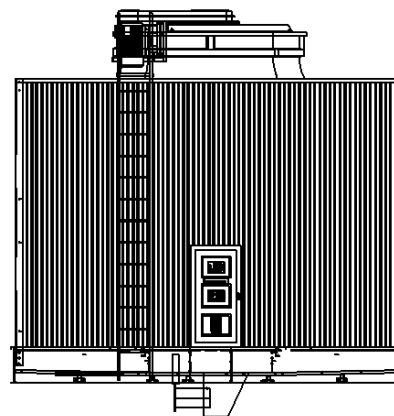

FRONT VIEW

Tower Model	Motor	Fan Diameter	Overall Dimension (mm)				Piping Dimension (mm)					
	kW	mm	L	W	H	h	External Piping	Internal Piping	Water Outlet	Overflow	Drain	Make Up Auto & Manual
EXS 0910Y	2.2	2440	2940	5550	3605	650	125	200	250	50	50	50
EXS 0910Z	3	2440	2940	5550	3605	650	125	200	250	50	50	50
EXS 0910A	4	2440	2940	5550	3605	650	125	200	250	50	50	50
EXS 0910B	5.5	2440	2940	5550	3605	650	125	200	250	50	50	50
EXS 0910C	7.5	2440	2940	5550	3605	650	125	200	250	50	50	50
EXS 0910D	11	2440	2940	5550	3605	650	125	200	250	50	50	50
EXS 0910E	15	2440	2940	5550	3605	650	125	200	250	50	50	50
EXS 0910F	18.5	2440	2940	5550	3605	650	125	200	250	50	50	50
EXS 0912Y	2.2	2440	2940	5550	4215	650	125	200	250	50	50	50
EXS 0912Z	3	2440	2940	5550	4215	650	150	200	250	80	50	50
EXS 0912A	4	2440	2940	5550	4215	650	125	200	250	50	50	50
EXS 0912B	5.5	2440	2940	5550	4215	650	150	200	250	80	50	50
EXS 0912C	7.5	2440	2940	5550	4215	650	125	200	250	50	50	50
EXS 0912D	11	2440	2940	5550	4215	650	150	200	250	80	50	50
EXS 0912E	15	2440	2940	5550	4215	650	150	200	250	80	50	50
EXS 0912F	18.5	2440	2940	5550	4215	650	150	200	250	80	50	50

EX-S SERIES RANGE

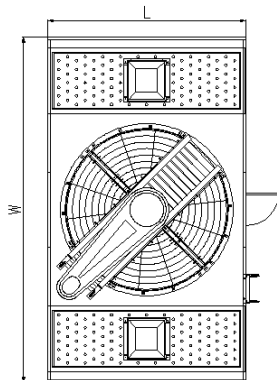

PLAN VIEW

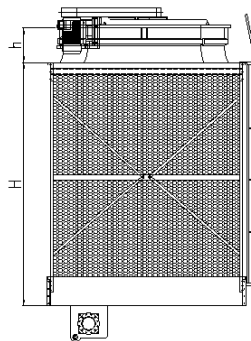

SIDE VIEW

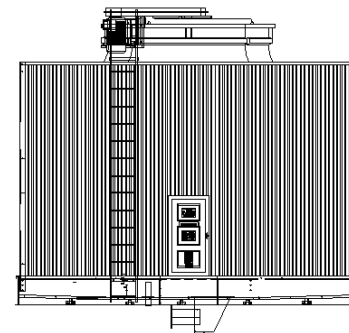

FRONT VIEW

Tower Model	Motor kW	Fan Diameter mm	Overall Dimension (mm)				Piping Dimension (mm)					
							External Piping	Internal Piping	Water Outlet	Overflow	Drain	Make Up Auto & Manual
			L	W	H	h						
EXS 1110A	4	2745	3430	6000	3605	650	150	200	250	80	50	50
EXS 1110B	5.5	2745	3430	6000	3605	650	150	200	250	80	50	50
EXS 1110C	7.5	2745	3430	6000	3605	650	150	200	250	80	50	50
EXS 1110D	11	2745	3430	6000	3605	650	150	200	250	80	50	50
EXS 1110E	15	2745	3430	6000	3605	650	150	200	250	80	50	50
EXS 1110F	18.5	2745	3430	6000	3605	650	150	200	250	80	50	50
EXS 1110G	22	2745	3430	6000	3605	650	200	200	300	100	50	50
EXS 1110H	30	2745	3430	6000	3605	650	200	200	300	100	50	50
EXS 1112B	5.5	2745	3430	6000	4215	650	200	200	300	100	50	50
EXS 1112C	7.5	2745	3430	6000	4215	650	200	250	300	100	50	50
EXS 1112D	11	2745	3430	6000	4215	650	200	250	300	100	50	50
EXS 1112E	15	2745	3430	6000	4215	650	200	200	300	100	50	50
EXS 1112F	18.5	2745	3430	6000	4215	650	200	250	300	100	50	50
EXS 1112G	22	2745	3430	6000	4215	650	200	250	300	100	50	50
EXS 1112H	30	2745	3430	6000	4215	650	200	250	300	100	50	50
EXS 1112I	37	2745	3430	6000	4215	650	200	250	300	100	50	50
EXS 1114B	5.5	2745	3430	6000	4825	650	200	250	300	100	50	50
EXS 1114C	7.5	2745	3430	6000	4825	650	200	250	300	100	50	50
EXS 1114D	11	2745	3430	6000	4825	650	200	250	300	100	50	50
EXS 1114E	15	2745	3430	6000	4825	650	200	250	300	100	50	50
EXS 1114F	18.5	2745	3430	6000	4825	650	200	250	300	100	50	50
EXS 1114G	22	2745	3430	6000	4825	650	200	250	300	100	50	50
EXS 1114H	30	2745	3430	6000	4825	650	200	250	300	100	50	50
EXS 1114I	37	2745	3430	6000	4825	650	200	250	300	100	50	50

EX-S SERIES RANGE

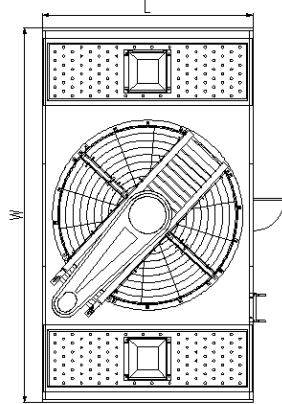

PLAN VIEW

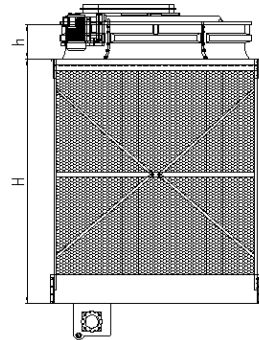

SIDE VIEW

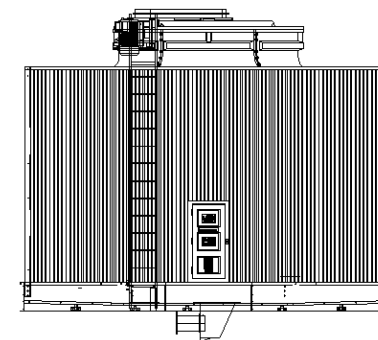

FRONT VIEW

Tower Model	Motor kW	Fan Diameter mm	Overall Dimension (mm)				Piping Dimension (mm)					
			L	W	H	h	External Piping	Internal Piping	Water Outlet	Overflow	Drain	Make Up Auto & Manual
EXS 1210B	5.5	3050	3620	6470	3605	650	150	250	250	100	50	50
EXS 1210C	7.5	3050	3620	6470	3605	650	200	250	300	100	50	50
EXS 1210D	11	3050	3620	6470	3605	650	150	250	250	100	50	50
EXS 1210E	15	3050	3620	6470	3605	650	200	250	300	100	50	50
EXS 1210F	18.5	3050	3620	6470	3605	650	200	250	300	100	50	50
EXS 1210G	22	3050	3620	6470	3605	650	200	250	300	100	50	50
EXS 1210H	30	3050	3620	6470	3605	650	200	250	300	100	50	50
EXS 1210I	37	3050	3620	6470	3605	650	200	250	300	100	50	50
EXS 1212C	7.5	3050	3620	6470	4215	650	200	250	300	100	50	50
EXS 1212D	11	3050	3620	6470	4215	650	200	250	300	100	50	50
EXS 1212E	15	3050	3620	6470	4215	650	200	250	300	100	50	50
EXS 1212F	18.5	3050	3620	6470	4215	650	200	250	300	100	50	50
EXS 1212G	22	3050	3620	6470	4215	650	200	250	300	100	50	50
EXS 1212H	30	3050	3620	6470	4215	650	200	250	300	100	50	50
EXS 1212I	37	3050	3620	6470	4215	650	200	300	300	100	50	50
EXS 1212J	45	3050	3620	6470	4215	650	200	300	300	100	50	50

EX-S SERIES RANGE

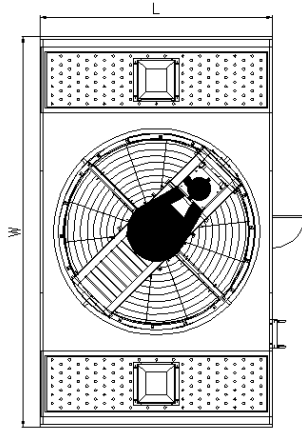

PLAN VIEW

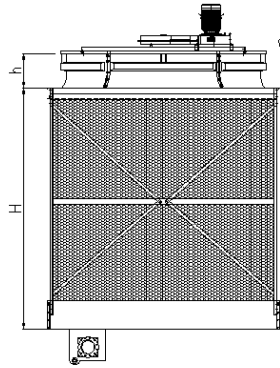

SIDE VIEW

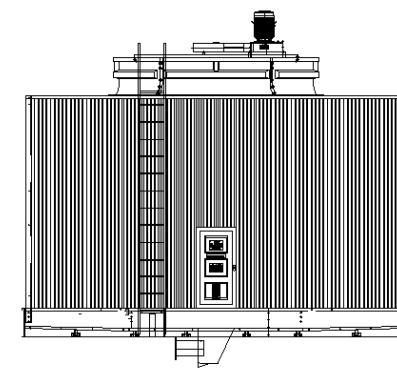

FRONT VIEW

Tower Model	Motor kW	Fan Diameter mm	Overall Dimension (mm)				Piping Dimension (mm)					
							External Piping	Internal Piping	Water Outlet	Overflow	Drain	Make Up Auto & Manual
			L	W	H	h						
EXS 1214C	7.5	3050	3620	6470	4825	650	200	250	300	100	50	50
EXS 1214D	11.0	3050	3620	6470	4825	650	200	250	300	100	50	50
EXS 1214E	15.0	3050	3620	6470	4825	650	200	250	300	100	50	50
EXS 1214F	18.5	3050	3620	6470	4825	650	200	250	300	100	50	50
EXS 1214G	22.0	3050	3620	6470	4825	650	200	250	300	100	50	50
EXS 1214H	30	3050	3620	6470	4825	650	200	300	300	100	50	50
EXS 1214I	37	3050	3620	6470	4825	650	200	300	300	100	50	50
EXS 1214J	45	3050	3620	6470	4825	650	200	300	300	100	50	50
EXS 1216C	7.5	3050	3620	6470	5435	650	200	250	300	100	50	50
EXS 1216D	11.0	3050	3620	6470	5435	650	200	250	300	100	50	50
EXS 1216E	15.0	3050	3620	6470	5435	650	200	250	300	100	50	50
EXS 1216F	18.5	3050	3620	6470	5435	650	200	250	300	100	50	50
EXS 1216G	22.0	3050	3620	6470	5435	650	200	250	300	100	50	50
EXS 1216H	30	3050	3620	6470	5435	650	200	300	300	100	50	50
EXS 1216I	37	3050	3620	6470	5435	650	200	300	300	100	50	50
EXS 1216J	45	3050	3620	6470	5435	650	200	300	300	100	50	50

EX-S SERIES RANGE

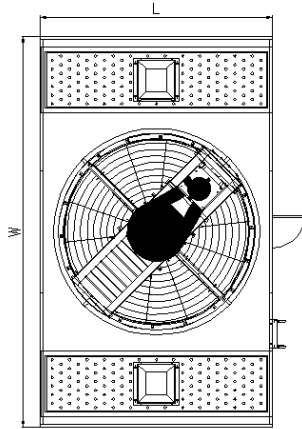

PLAN VIEW

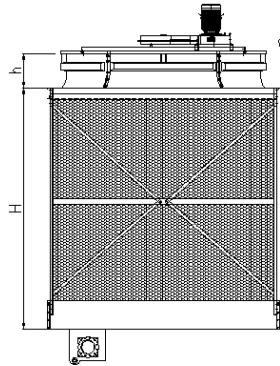

SIDE VIEW

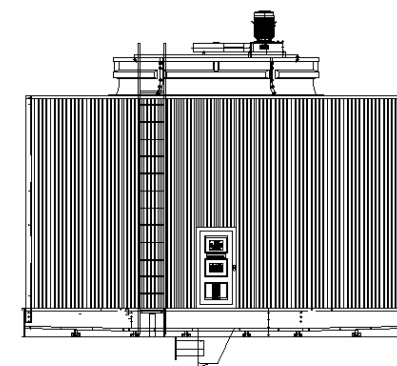

FRONT VIEW

Tower Model	Motor kW	Fan Diameter mm	Overall Dimension (mm)				Piping Dimension (mm)					
							External Piping	Internal Piping	Water Outlet	Overflow	Drain	Make Up Auto & Manual
			L	W	H	h						
EXS 1312C	7.5	3355	4070	6830	4215	650	200	250	300	100	50	50
EXS 1312D	11	3355	4070	6830	4215	650	200	250	300	100	50	50
EXS 1312E	15.0	3355	4070	6830	4215	650	200	250	300	100	50	50
EXS 1312F	18.5	3355	4070	6830	4215	650	200	250	300	100	50	50
EXS 1312G	22.0	3355	4070	6830	4215	650	200	250	300	100	50	50
EXS 1312H	30.0	3355	4070	6830	4215	650	200	300	300	100	50	50
EXS 1312I	37.0	3355	4070	6830	4215	650	200	300	300	100	50	50
EXS 1312J	45.0	3355	4070	6830	4215	650	200	300	300	100	50	50
EXS 1314D	11.0	3355	4070	6830	4825	650	200	300	300	100	50	50
EXS 1314E	15.0	3355	4070	6830	4825	650	200	300	300	100	50	50
EXS 1314F	18.5	3355	4070	6830	4825	650	200	300	300	100	50	50
EXS 1314G	22.0	3355	4070	6830	4825	650	200	300	300	100	50	50
EXS 1314H	30.0	3355	4070	6830	4825	650	200	300	300	100	50	50
EXS 1314I	37.0	3355	4070	6830	4825	650	200	300	350	100	50	50
EXS 1314J	45.0	3355	4070	6830	4825	650	200	300	350	100	50	50
EXS 1314K	55	3355	4070	6830	4825	650	200	300	350	100	50	50

EX-S SERIES RANGE

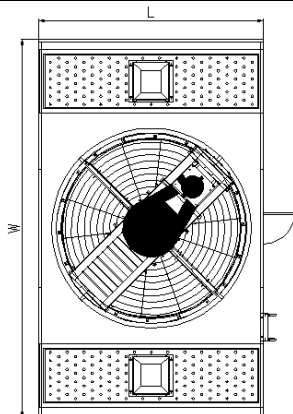

PLAN VIEW

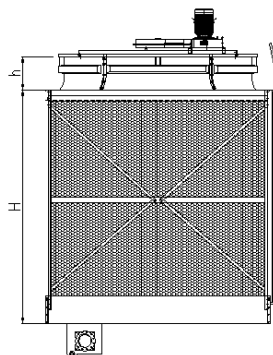

SIDE VIEW

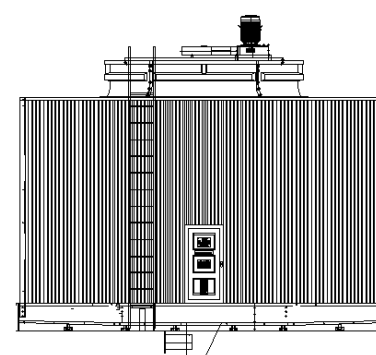

FRONT VIEW

Tower Model	Motor kW	Fan Diameter mm	Overall Dimension (mm)				Piping Dimension (mm)					
			L	W	H	h	External Piping	Internal Piping	Water Outlet	Overflow	Drain	Make Up Auto & Manual
EXS 1316D	11	3355	4070	6830	5435	650	200	300	350	100	50	50
EXS 1316E	15	3355	4070	6830	5435	650	200	300	350	100	50	50
EXS 1316F	18.5	3355	4070	6830	5435	650	200	300	350	100	50	50
EXS 1316G	22.0	3355	4070	6830	5435	650	200	300	350	100	50	50
EXS 1316H	30.0	3355	4070	6830	5435	650	200	300	350	100	50	50
EXS 1316I	37.0	3355	4070	6830	5435	650	200	300	350	100	50	50
EXS 1316J	45.0	3355	4070	6830	5435	650	200	300	350	100	50	50
EXS 1316K	55.0	3355	4070	6830	5435	650	200	300	350	100	50	50
EXS 1318D	11.0	3355	4070	6830	6045	650	200	350	350	100	50	50
EXS 1318E	15.0	3355	4070	6830	6045	650	200	350	350	100	50	50
EXS 1318F	18.5	3355	4070	6830	6045	650	200	350	350	100	50	50
EXS 1318G	22.0	3355	4070	6830	6045	650	200	350	350	100	50	50
EXS 1318H	30.0	3355	4070	6830	6045	650	200	350	350	100	50	50
EXS 1318I	37.0	3355	4070	6830	6045	650	200	350	350	100	50	50
EXS 1318J	45.0	3355	4070	6830	6045	650	200	350	350	100	50	50
EXS 1318K	55.0	3355	4070	6830	6045	650	200	350	350	100	50	50

EX-S SERIES RANGE

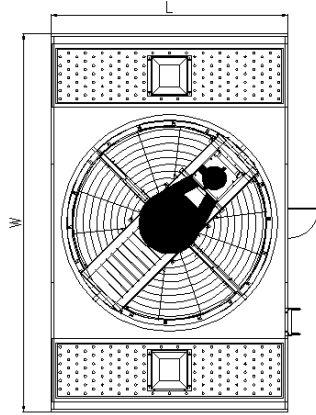

PLAN VIEW

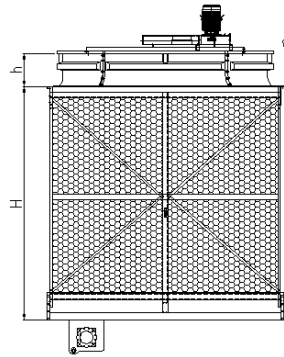

SIDE VIEW

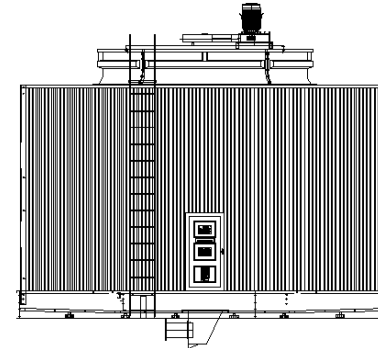

FRONT VIEW

Tower Model	Motor kW	Fan Diameter mm	Overall Dimension (mm)				Piping Dimension (mm)					
							External Piping	Internal Piping	Water Outlet	Overflow	Drain	Make Up Auto & Manual
			L	W	H	h						
EXS 1412D	11	3660	4280	6830	4215	650	200	350	350	100	50	50
EXS 1412E	15	3660	4280	6830	4215	650	200	350	350	100	50	50
EXS 1412F	18.5	3660	4280	6830	4215	650	200	350	350	100	50	50
EXS 1412G	22.0	3660	4280	6830	4215	650	200	350	350	100	50	50
EXS 1412H	30.0	3660	4280	6830	4215	650	200	350	350	100	50	50
EXS 1412I	37.0	3660	4280	6830	4215	650	200	350	350	100	50	50
EXS 1412J	45.0	3660	4280	6830	4215	650	200	350	350	100	50	50
EXS 1412K	55.0	3660	4280	6830	4215	650	200	350	350	100	50	50
EXS 1414D	11.0	3660	4280	6830	4825	650	200	350	350	100	50	50
EXS 1414E	15.0	3660	4280	6830	4825	650	200	350	350	100	50	50
EXS 1414F	18.5	3660	4280	6830	4825	650	200	350	350	100	50	50
EXS 1414G	22.0	3660	4280	6830	4825	650	200	350	350	100	50	50
EXS 1414H	30.0	3660	4280	6830	4825	650	200	350	350	100	50	50
EXS 1414I	37.0	3660	4280	6830	4825	650	200	350	350	100	50	50
EXS 1414J	45.0	3660	4280	6830	4825	650	200	350	350	100	50	50
EXS 1414K	55.0	3660	4280	6830	4825	650	200	350	350	100	50	50

EX-S SERIES RANGE

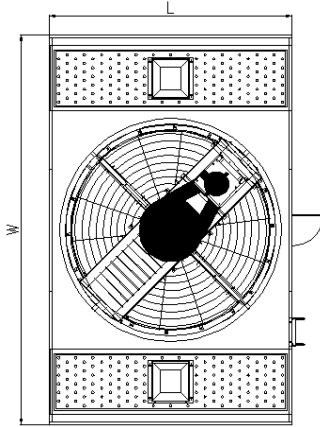

PLAN VIEW

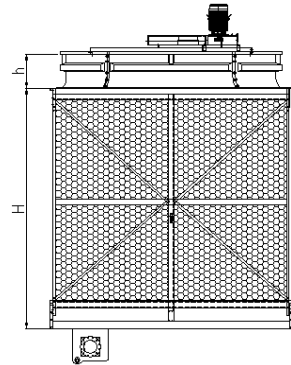

SIDE VIEW

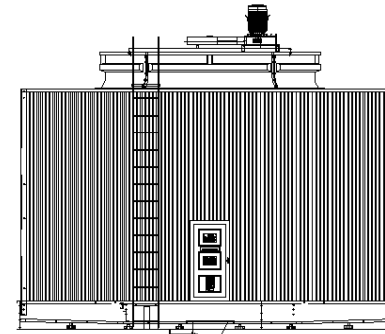

FRONT VIEW

Tower Model	Motor kW	Fan Diameter mm	Overall Dimension (mm)				Piping Dimension (mm)					
							External Piping	Internal Piping	Water Outlet	Overflow	Drain	Make Up Auto & Manual
			L	W	H	h						
EXS 1416D	11	3660	4280	6830	5435	650	200	350	350	100	50	50
EXS 1416E	15	3660	4280	6830	5435	650	200	350	350	100	50	50
EXS 1416F	18.5	3660	4280	6830	5435	650	200	350	350	100	50	50
EXS 1416G	22.0	3660	4280	6830	5435	650	200	350	350	100	50	50
EXS 1416H	30.0	3660	4280	6830	5435	650	200	350	350	100	50	50
EXS 1416I	37.0	3660	4280	6830	5435	650	200	350	350	100	50	50
EXS 1416J	45.0	3660	4280	6830	5435	650	200	350	350	100	50	50
EXS 1416K	55.0	3660	4280	6830	5435	650	200	350	350	100	50	50
EXS 1418D	11.0	3660	4280	6830	6045	650	200	350	350	100	50	50
EXS 1418E	15.0	3660	4280	6830	6045	650	200	350	350	100	50	50
EXS 1418F	18.5	3660	4280	6830	6045	650	200	350	350	100	50	50
EXS 1418G	22.0	3660	4280	6830	6045	650	200	350	350	100	50	50
EXS 1418H	30.0	3660	4280	6830	6045	650	200	350	350	100	50	50
EXS 1418I	37.0	3660	4280	6830	6045	650	200	350	350	100	50	50
EXS 1418J	45.0	3660	4280	6830	6045	650	200	350	350	100	50	50
EXS 1418K	55.0	3660	4280	6830	6045	650	200	350	350	100	50	50

EX-S SERIES RANGE

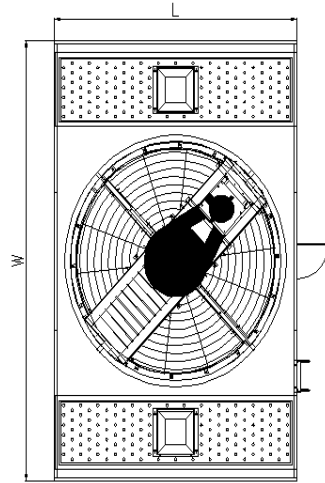

PLAN VIEW

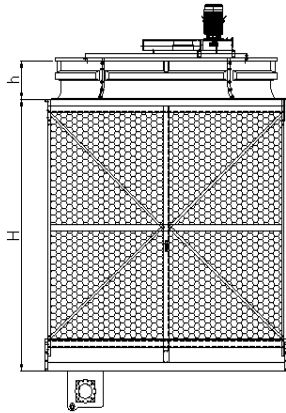

SIDE VIEW

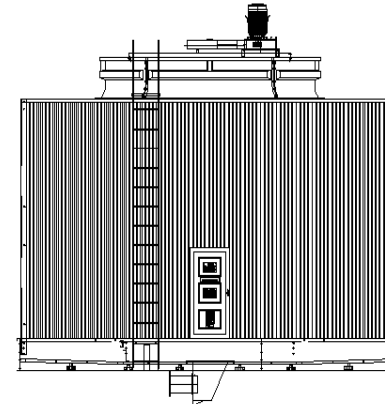

FRONT VIEW

Tower Model	Motor kW	Fan Diameter mm	Overall Dimension (mm)				Piping Dimension (mm)					
							External Piping	Internal Piping	Water Outlet	Overflow	Drain	Make Up Auto & Manual
			L	W	H	h						
EXS 1420D	11.0	3660	4280	6830	6655	650	200	350	350	100	50	50
EXS 1420E	15.0	3660	4280	6830	6655	650	200	350	350	100	50	50
EXS 1420F	18.5	3660	4280	6830	6655	650	200	350	350	100	50	50
EXS 1420G	22.0	3660	4280	6830	6655	650	200	350	350	100	50	50
EXS 1420H	30.0	3660	4280	6830	6655	650	200	350	350	100	50	50
EXS 1420I	37.0	3660	4280	6830	6655	650	200	350	350	100	50	50
EXS 1420J	45.0	3660	4280	6830	6655	650	200	350	350	100	50	50
EXS 1420K	55.0	3660	4280	6830	6655	650	200	350	350	100	50	50
EXS 1420L	75.0	3660	4280	6830	6655	650	200	350	350	100	50	50

EX-S SERIES RANGE

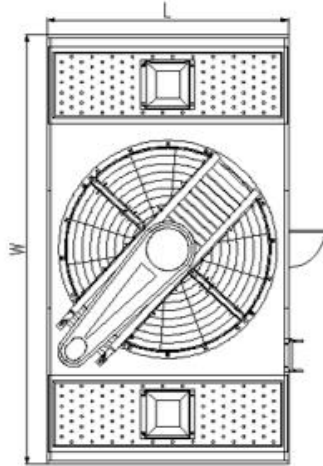

PLAN VIEW

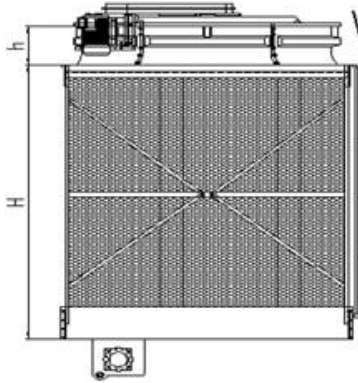

SIDE VIEW

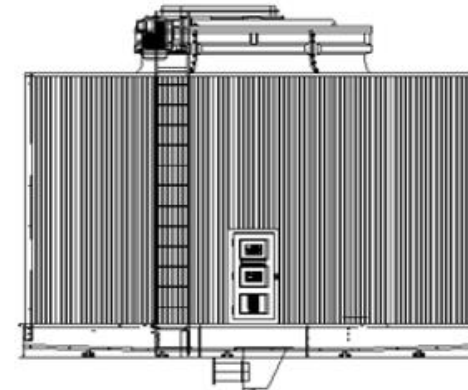

FRONT VIEW

Tower Model	Motor kW	Fan Diameter mm	Overall Dimension (mm)				Piping Dimension (mm)					
							External Piping	Internal Piping	Water Outlet	Overflow	Drain	Make-up Auto & Manual
			L	W	H	h						
EXS 1209A	4	3050	3620	6830	3300	650	200	150	200	50	50	50
EXS 1209B	5.5	3050	3620	6830	3300	650	200	150	250	80	50	50
EXS 1209C	7.5	3050	3620	6830	3300	650	250	200	250	80	50	50
EXS 1209D	11.0	3050	3620	6830	3300	650	250	200	300	10	50	50
EXS 1209E	15.0	3050	3620	6830	3300	650	250	200	300	10	50	50
EXS 1209F	18.5	3050	3620	6830	3300	650	250	200	300	10	50	50
EXS 1209G	22.0	3050	3620	6830	3300	650	250	200	300	10	50	50
EXS 1209H	30.0	3050	3620	6830	3300	650	250	200	300	10	50	50
EXS 1209I	37.0	3050	3620	6830	3300	650	250	200	300	10	50	50
EXS 1209J	45.0	3050	3620	6830	3300	650	250	200	300	10	50	50

EX-S SERIES RANGE

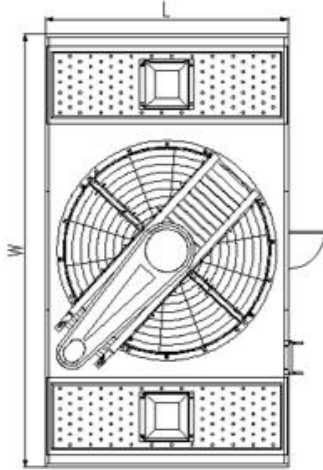

PLAN VIEW

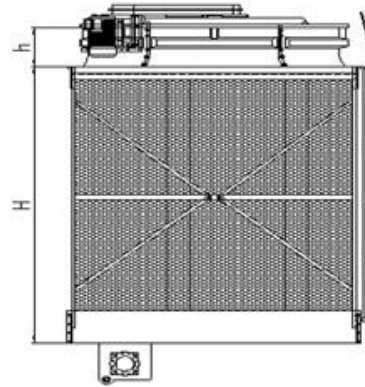

SIDE VIEW

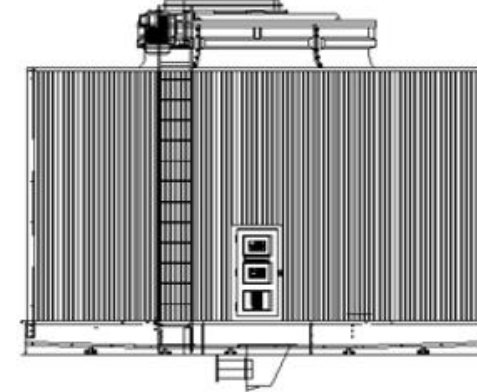

FRONT VIEW

Tower Model	Motor kW	Fan Diameter mm	Overall Dimension (mm)				Piping Dimension (mm)					
							External Piping	Internal Piping	Water Outlet	Overflow	Drain	Make-up Auto & Manual
			L	W	H	h						
EXS 1309B	5.5	3355	4070	7130	3300	650	250	200	250	80	50	50
EXS 1309C	7.5	3355	4070	7130	3300	650	250	200	250	80	50	50
EXS 1309D	11.0	3355	4070	7130	3300	650	250	200	300	10	50	50
EXS 1309E	15.0	3355	4070	7130	3300	650	250	200	300	10	50	50
EXS 1309F	18.5	3355	4070	7130	3300	650	250	200	300	10	50	50
EXS 1309G	22.0	3355	4070	7130	3300	650	250	200	300	10	50	50
EXS 1309H	30.0	3355	4070	7130	3300	650	250	200	300	10	50	50
EXS 1309I	37.0	3355	4070	7130	3300	650	250	200	300	10	50	50
EXS 1309J	45.0	3355	4070	7130	3300	650	300	200	300	10	50	50

EX-S SERIES RANGE

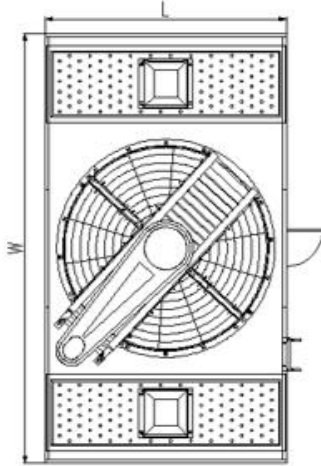

PLAN VIEW

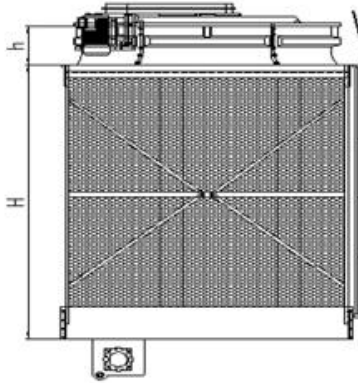

SIDE VIEW

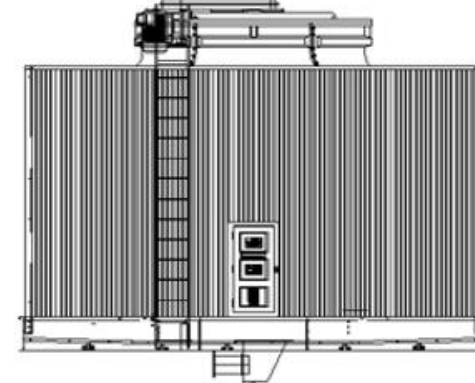

FRONT VIEW

Tower Model	Motor kW	Fan Diameter mm	Overall Dimension (mm)				Piping Dimension (mm)					
							External Piping	Internal Piping	Water Outlet	Overflow	Drain	Make-up Auto & Manual
			L	W	H	h						
EXS 1409C	7.5	3660	4280	7440	3300	650	250	200	300	10	50	50
EXS 1409D	11.0	3660	4280	7440	3300	650	250	200	300	10	50	50
EXS 1409E	15.0	3660	4280	7440	3300	650	250	200	300	10	50	50
EXS 1409F	18.5	3660	4280	7440	3300	650	250	200	300	10	50	50
EXS 1409G	22.0	3660	4280	7440	3300	650	250	200	300	10	50	50
EXS 1409H	30.0	3660	4280	7440	3300	650	250	200	300	10	50	50
EXS 1409I	37.0	3660	4280	7440	3300	650	300	200	300	10	50	50
EXS 1409J	45.0	3660	4280	7440	3300	650	300	250	300	10	50	50
EXS 1409K	55.0	3660	4280	7440	3300	650	300	250	300	10	50	50