

Rosemex Inc.

1560 Marie-Victorin Blvd., Saint-Bruno, Montreal, Quebec, Canada J3V 6B9

TEL: 1-450-6531002

FAX: 1-450-6533464

URL: www.rosemex.com

Shanghai Office

4thFloor, 4727 Gonghexin Rd., Shanghai, China, 200435

TEL: (86)-21-56389411

FAX: (86)-21-56382762

URL: www.rosemex-coolingtower.com

MAIL: sales@rosemex-coolingtower.com

Contacts: Alfred Ng, 1-604-6578741



RCS/D Closed Mixed Flow, Induced-draft Cooling Tower

Design Information

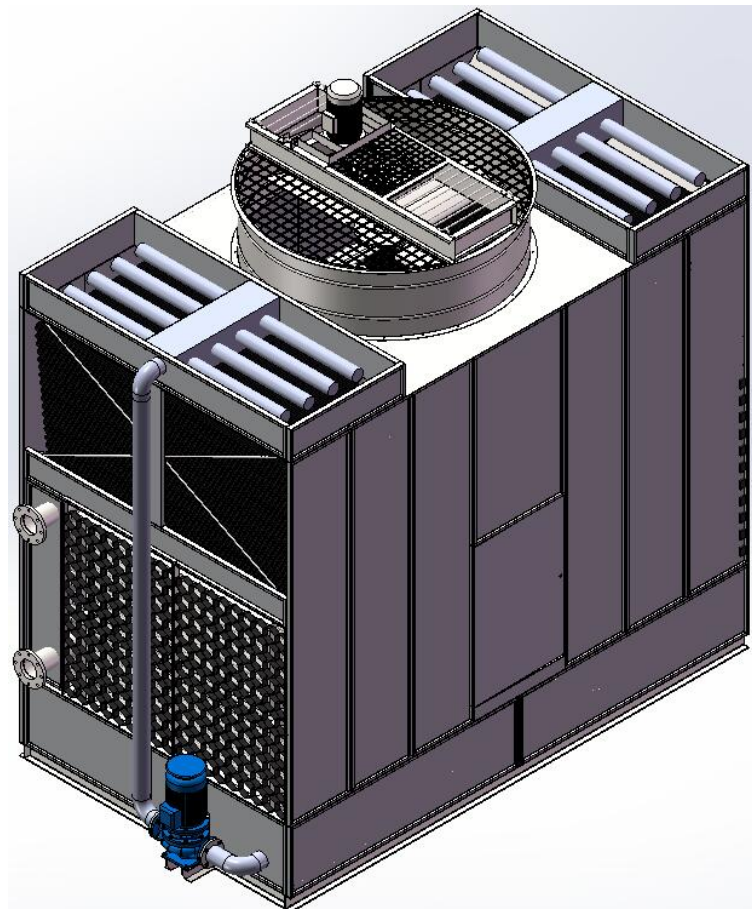

I. Outline of models

(closed type, Mixed Flow, and induced draft)

Models	Cooling capacity (37-32-28 °C)	Inlet and outlet pipe Diameter of host machine	Water rate	Spray pump			Fan		Outline dimension			Weight of host machine	Operating weight
				Inlet-Outlet Diameter,	Impeller Size,	Motor Size	Power	Diameter	Length	Width	Height		
	KCAL	mm	(m ³ /h)	mm	mm	kW/ Poles	(KW)	(mm)	mm	mm	mm	(kg)	(kg)
RCS-012ED	100000	DN100	20	80	Φ98	1. 1/2	2.2	1100	1528	2250	4150	1300	2200
RCS-012EG	110000	DN100	22	80	Φ98	1. 1/2	3	1100	1528	2250	4150	1325	2220
RCS-013ED	120000	DN100	24	80	Φ98	1. 1/2	3	1100	1528	2250	4150	1350	2250
RCS-013EG	130000	DN100	26	80	Φ98	1. 1/2	4	1100	1528	2250	4150	1380	2300
RCS-062ED	155000	DN100	31	80	Φ115	1. 5/2	3	1200	1850	2610	4150	2000	3330
RCS-062EG	170000	DN100	34	80	Φ115	1. 5/2	4	1200	1850	2610	4150	2025	3350
RCS-063ED	175000	DN100	35	80	Φ115	1. 5/2	4	1200	1850	2610	4150	2100	3450
RCS-063EG	195000	DN100	39	80	Φ115	1. 5/2	5. 5	1200	1850	2610	4150	2125	3490
RCS-132ED	180000	DN100	36	80	Φ130	2. 2/2	4	1300	1850	2896	4150	2200	3500
RCS-132EG	200000	DN100	40	80	Φ130	2. 2/2	5. 5	1300	1850	2896	4150	2225	3525
RCS-133ED	215000	DN100	43	80	Φ130	2. 2/2	5. 5	1300	1850	2896	4150	2420	3650
RCS-133EG	235000	DN100	47	80	Φ130	2. 2/2	7. 5	1300	1850	2896	4150	2450	3690
RCS-153ED	345000	DN100	69	100	Φ130	2. 2/2	5. 5	1800	2250	3540	4150	3150	5460
RCS-153EG	380000	DN100	76	100	Φ130	2. 2/2	7. 5	1800	2250	3540	4150	3260	5570
RCS-154HD	420000	DN100	84	100	Φ145	3. 0/2	7. 5	1800	2250	3540	4980	3680	6050
RCS-154HG	475000	DN100	95	100	Φ145	3. 0/2	11	1800	2250	3540	4980	3750	6120
RCD-341BD	225000	DN100	45	80	Φ98	1. 1/2	4	1600	2250	3792	3550	2300	4650
RCD-342BD	250000	DN100	50	80	Φ98	1. 1/2	4	1600	2250	3792	3550	2450	4800
RCD-342ED	280000	DN100	56	80	Φ98	1. 1/2	4	1600	2250	3792	4150	3000	5300
RCD-342EP	320000	DN100	64	80	Φ98	1. 1/2	5. 5	1600	2250	3792	4150	3060	5360
RCD-343EP	355000	DN100	71	80	Φ98	1. 1/2	5. 5	1600	2250	3792	4150	3300	5650
RCD-343EL	390000	DN100	78	80	Φ98	1. 1/2	7. 5	1600	2250	3792	4150	3350	5700



RCD-361BD	365000	DN100	73	80	Φ 115	1.5/2	5.5	2200	2476	4792	3550	3800	7050
RCD-362BP	425000	DN100	85	80	Φ 115	1.5/2	7.5	2200	2476	4792	3550	3980	7100
RCD-362ED	455000	DN125	91	80	Φ 115	1.5/2	7.5	2200	2476	4792	4150	4350	7600
RCD-362EP	525000	DN125	105	80	Φ 115	1.5/2	11	2200	2476	4792	4150	4400	7650
RCD-363ED	520000	DN125	104	80	Φ 115	1.5/2	7.5	2200	2476	4792	4150	4500	7800
RCD-363EP	560000	DN125	112	80	Φ 115	1.5/2	11	2200	2476	4792	4150	4580	7850
RCD-363HP	585000	DN125	117	80	Φ 115	1.5/2	11	2200	2476	4792	4980	4900	8100
RCD-363HG	650000	DN125	130	80	Φ 115	1.5/2	15	2200	2476	4792	4980	4980	8200
RCD-364HP	685000	DN125	137	80	Φ 115	1.5/2	11	2200	2476	4792	4980	5100	8600
RCD-364HG	770000	DN125	154	80	Φ 115	1.5/2	15	2200	2476	4792	4980	5180	8700
RCD-381BD	505000	DN125	101	100	Φ 130	2.2/4	7.5	2600	2976	5220	3550	4500	8430
RCD-382BP	575000	DN125	115	100	Φ 130	2.2/4	11	2600	2976	5220	3550	4700	8500
RCD-382ED	615000	DN125	123	100	Φ 130	2.2/4	11	2600	2976	5220	4150	5220	9120
RCD-382EP	685000	DN125	137	100	Φ 130	2.2/4	15	2600	2976	5220	4150	5300	9200
RCD-383ED	670000	DN125	134	100	Φ 130	2.2/4	11	2600	2976	5220	4150	5500	9500
RCD-383EP	745000	DN125	149	100	Φ 130	2.2/4	15	2600	2976	5220	4150	5550	9550
RCD-383HP	825000	DN125	165	100	Φ 130	2.2/4	15	2600	2976	5220	4980	6050	10050
RCD-383HG	870000	DN125	174	100	Φ 130	2.2/4	18.5	2600	2976	5220	4980	6100	10100
RCD-384HD	875000	DN125	175	100	Φ 130	2.2/4	15	2600	2976	5220	4980	6500	10700
RCD-384HP	945000	DN125	189	100	Φ 130	2.2/4	18.5	2600	2976	5220	4980	6580	10800
RCD-384HG	1005000	DN125	201	100	Φ 130	2.2/4	22	2600	2976	5220	4980	6650	10850
RCD-393ED	1220000	DN150	244	100	Φ 145	3/4	18.5	3200	3620	6396	4150	7450	12300
RCD-393EP	1295000	DN150	259	100	Φ 145	3/4	22	3200	3620	6396	4150	7500	12380
RCD-393EG	1435000	DN150	287	100	Φ 145	3/4	30	3200	3620	6396	4150	7630	12500
RCD-393HD	1350000	DN150	270	100	Φ 145	3/4	22	3200	3620	6396	4980	8300	13180
RCD-393HP	1490000	DN150	298	100	Φ 145	3/4	30	3200	3620	6396	4980	8420	13300
RCD-393HG	1600000	DN150	320	100	Φ 145	3/4	37	3200	3620	6396	4980	8550	13430
RCD-394HD	1500000	DN150	300	100	Φ 145	3/4	30	3200	3620	6396	4980	8720	13750
RCD-394HP	1610000	DN150	322	100	Φ 145	3/4	37	3200	3620	6396	4980	8850	13900
RCD-394HG	1710000	DN150	342	100	Φ 145	3/4	45	3200	3620	6396	4980	9000	14100



RCD-413ED	1355000	DN150	271	150	Φ 185	5. 5/4	18. 5	3400	3620	7316	5020	15550	22400
RCD-413EL	1440000	DN150	288	150	Φ 185	5. 5/4	22	3400	3620	7316	5020	15650	22500
RCD-413EP	1600000	DN150	320	150	Φ 185	5. 5/4	30	3400	3620	7316	5020	15800	22650
RCD-413EG	1715000	DN150	343	150	Φ 185	5. 5/4	37	3400	3620	7316	5020	15950	22800
RCD-413HD	1525000	DN200	305	150	Φ 185	5. 5/4	22	3400	3620	7316	6050	16200	23050
RCD-413HL	1695000	DN200	339	150	Φ 185	5. 5/4	30	3400	3620	7316	6050	16350	23200
RCD-413HP	1800000	DN200	360	150	Φ 185	5. 5/4	37	3400	3620	7316	6050	16500	23350
RCD-413HG	1925000	DN200	385	150	Φ 185	5. 5/4	45	3400	3620	7316	6050	16650	23500
RCD-414HD	1815000	DN200	363	150	Φ 185	5. 5/4	30	3400	3620	7316	6050	17550	24950
RCD-414HL	1945000	DN200	389	150	Φ 185	5. 5/4	37	3400	3620	7316	6050	17700	25100
RCD-414HP	2075000	DN200	415	150	Φ 185	5. 5/4	45	3400	3620	7316	6050	17850	25250
RCD-414HG	2220000	DN200	444	150	Φ 185	5. 5/4	55	3400	4250	7960	6050	18050	25450
RCD-433ED	1685000	DN150	337	150	Φ 185	5. 5/4	22	3900	4250	7960	5020	17670	25240
RCD-433EL	1875000	DN150	375	150	Φ 185	5. 5/4	30	3900	4250	7960	5020	17830	25400
RCD-433EP	2010000	DN150	402	150	Φ 185	5. 5/4	37	3900	4250	7960	5020	17970	25540
RCD-433EG	2140000	DN150	428	150	Φ 185	5. 5/4	45	3900	4250	7960	5020	18130	25700
RCD-433HD	1985000	DN200	397	150	Φ 185	5. 5/4	30	3900	4250	7960	6050	18440	26000
RCD-433HL	2125000	DN200	425	150	Φ 185	5. 5/4	37	3900	4250	7960	6050	18580	26140
RCD-433HP	2270000	DN200	454	150	Φ 185	5. 5/4	45	3900	4250	7960	6050	18740	26300
RCD-433HG	2425000	DN200	485	150	Φ 185	5. 5/4	55	3900	4250	7960	6050	18940	26500
RCD-434HD	2125000	DN200	425	150	Φ 185	5. 5/4	30	3900	4250	7960	6050	19950	28120
RCD-434HL	2280000	DN200	456	150	Φ 185	5. 5/4	37	3900	4250	7960	6050	20100	28270
RCD-434HP	2400000	DN200	480	150	Φ 185	5. 5/4	45	3900	4250	7960	6050	20260	28430
RCD-434HG	2550000	DN200	510	150	Φ 185	5. 5/4	55	3900	4250	7960	6050	20460	28630

* Significance of the model names:

R	C	S/D	-	062E	D
Rosemex	Closed Cooling Tower	Single/Double Louver		Unit Model	Fan code

II. Drawings:

1) Model RCS-012(ED/EG)

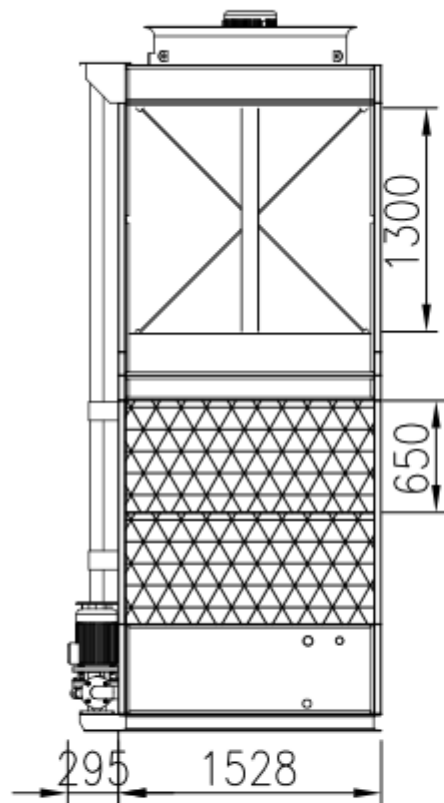

VIEW 2

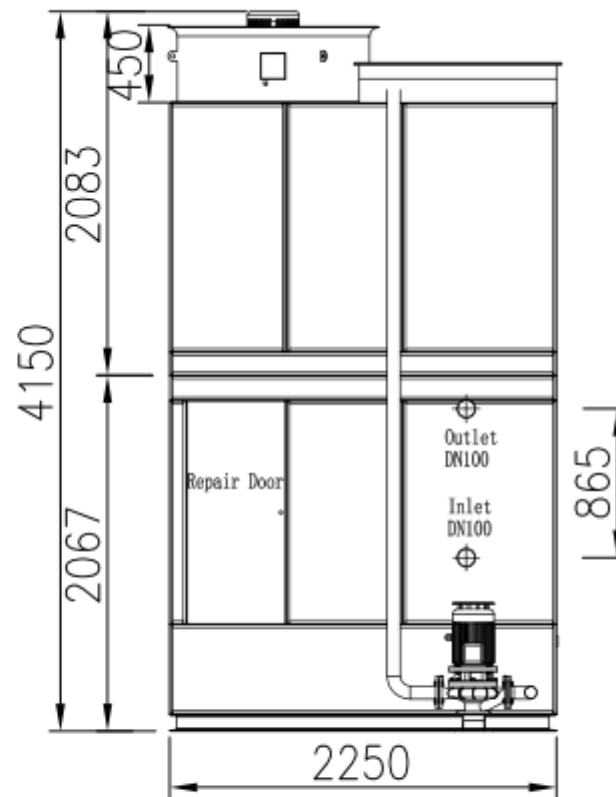

VIEW 1

2) Model RCS-013(ED/EG)

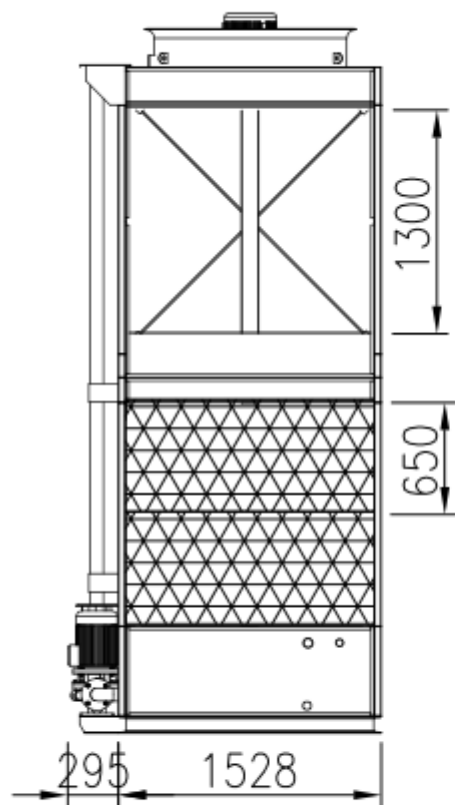

VIEW 2

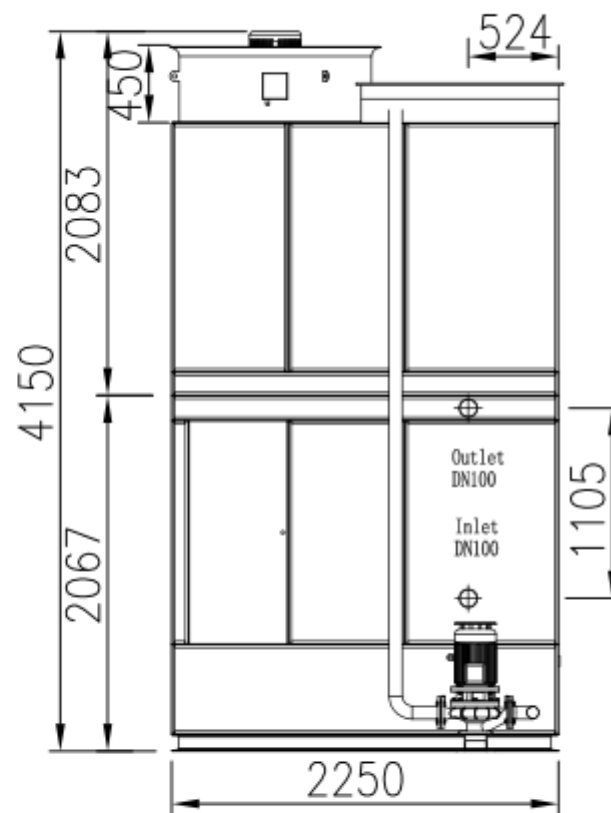

VIEW 1

3) Model RCS-062(ED/EG)

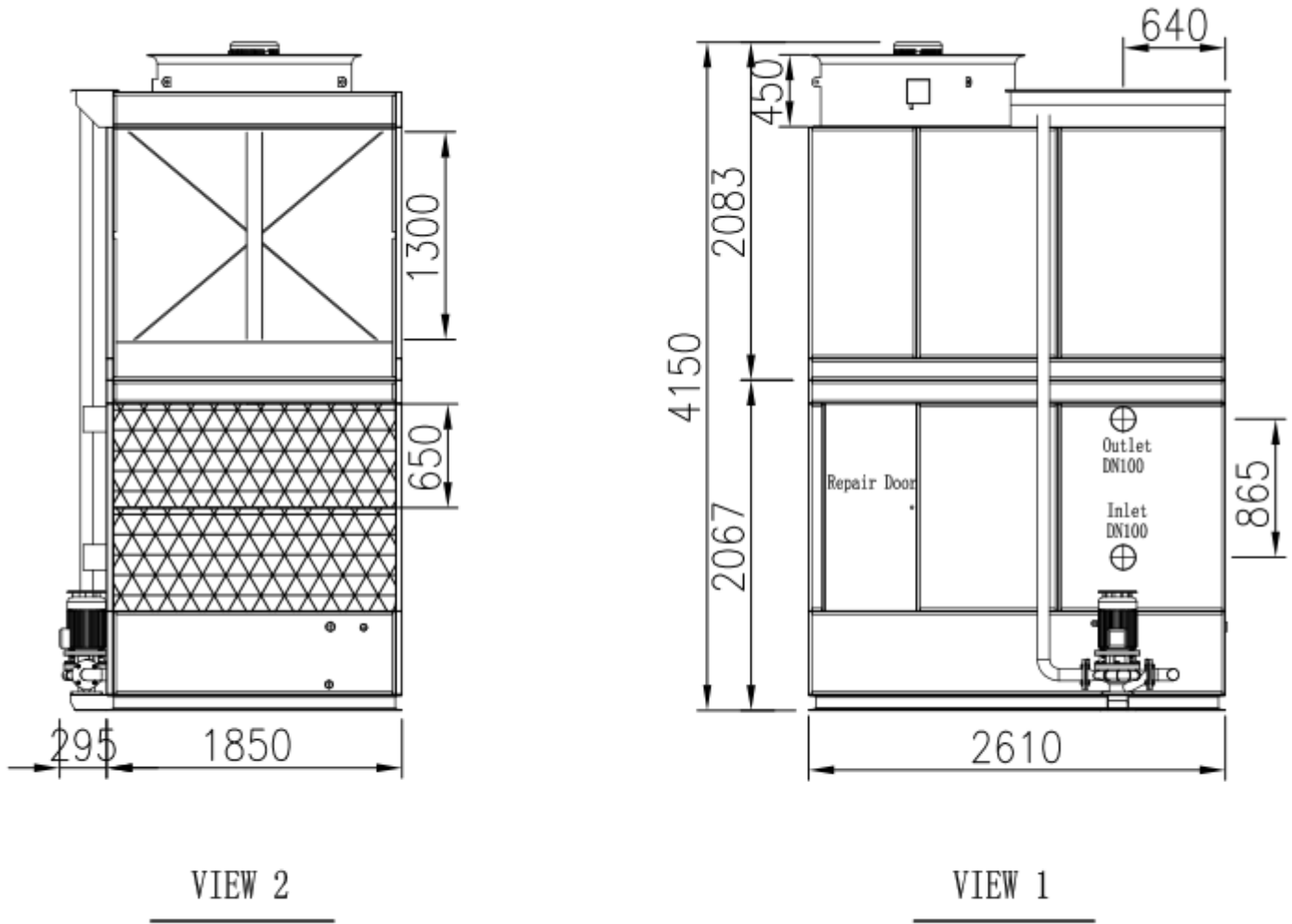

4) Model RCS-063(ED/EG)

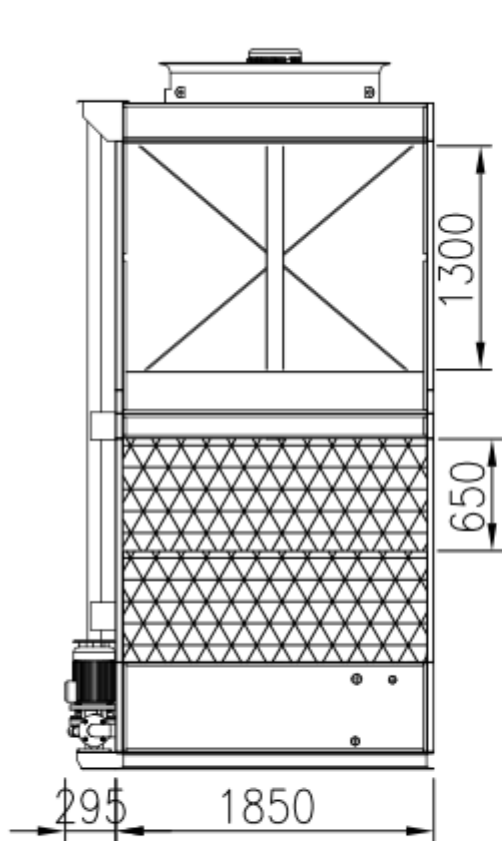

VIEW 2

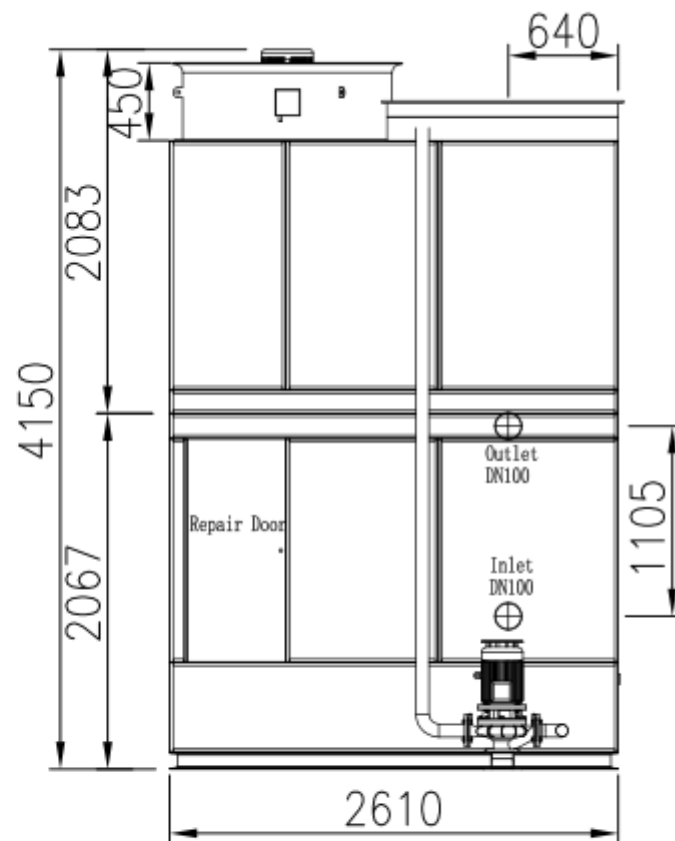

VIEW 1

5) Model RCS-132(ED/EG)

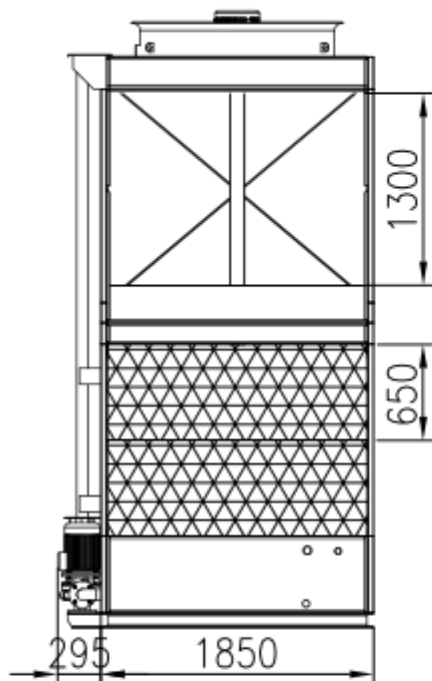

VIEW 2

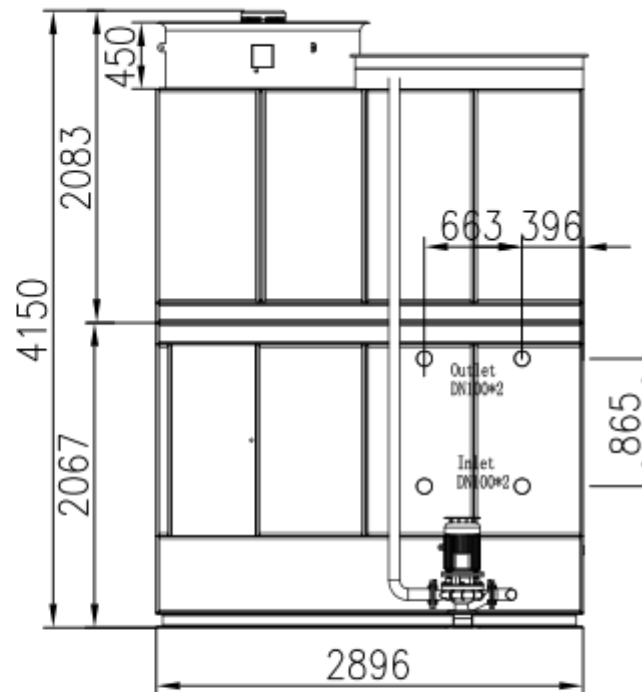

VIEW 1

6) Model RCS-133(ED/EG)

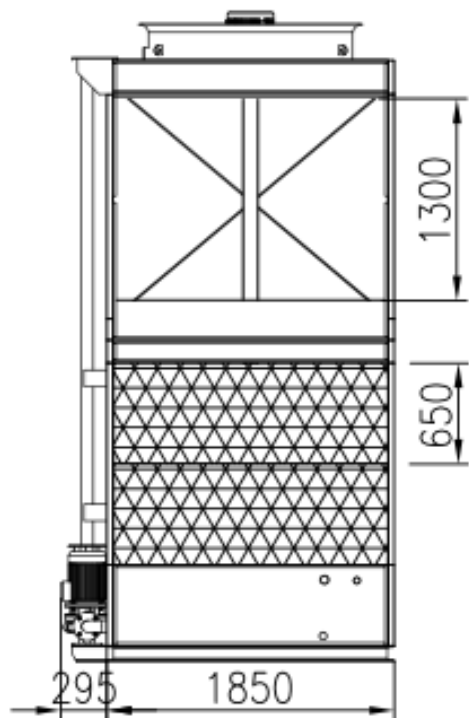

VIEW 2

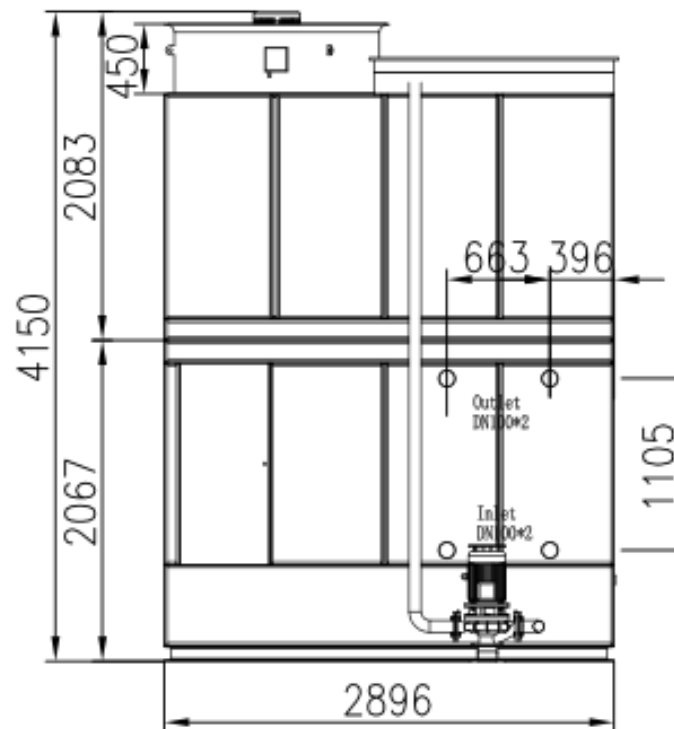

VIEW 1

7) Model RCS-153(ED/EG)

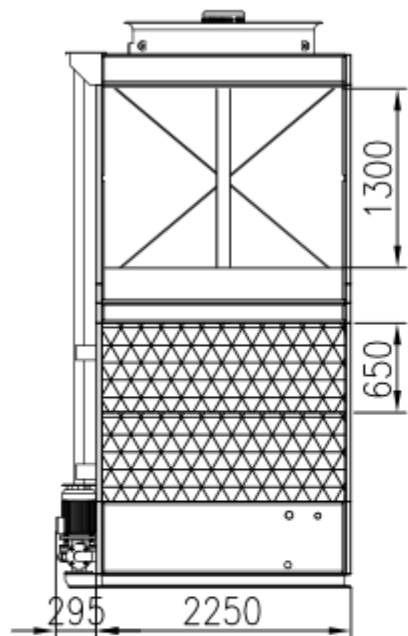

VIEW 2

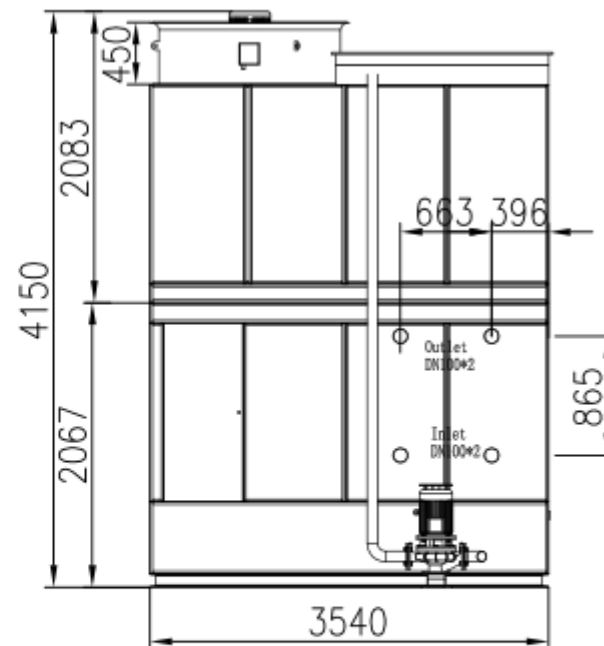

VIEW 1

8) Model RCS-154(HD/HG)

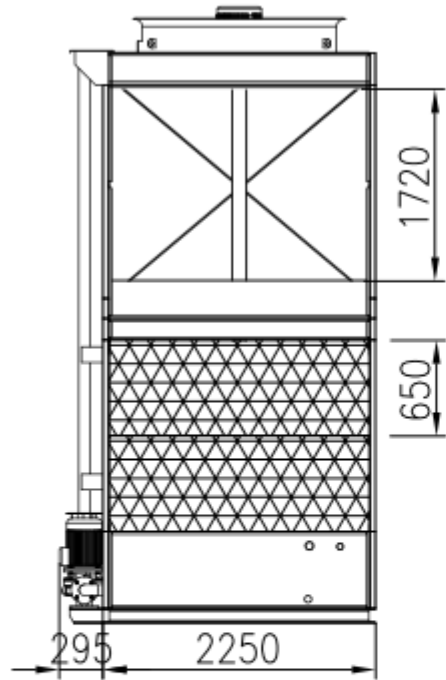

VIEW 2

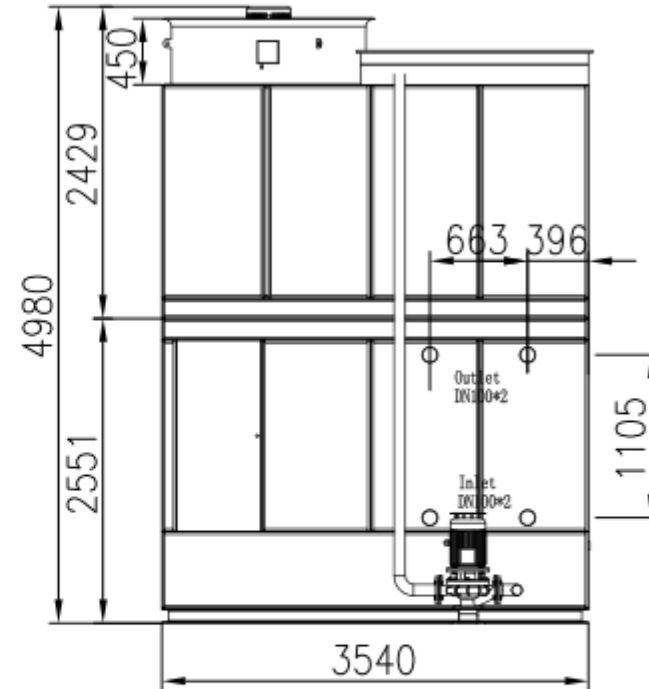

VIEW 1

9) Model RCD-34X

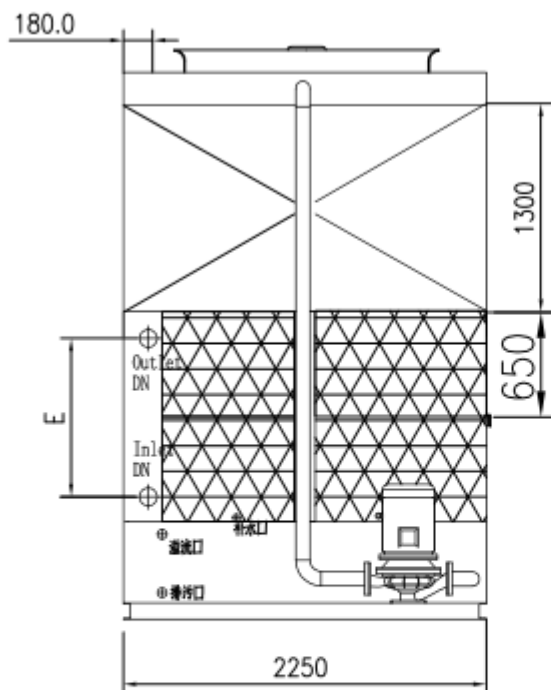

VIEW 2

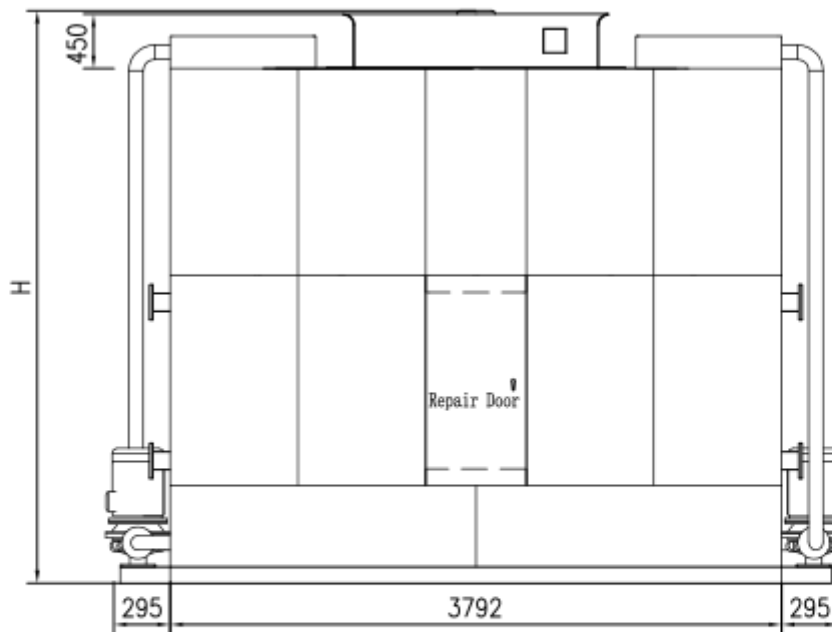

VIEW 1

型号	H	E	DN
FBHL-341BD	3550	625	100x2
FBHL-342BD	3550	865	100x2
FBHL-342ED	4150	865	100x2
FBHL-342EP	4150	865	100x2
FBHL-343EP	4150	1105	100x2
FBHL-343EL	4150	1105	100x2

10) Model RCD-36X

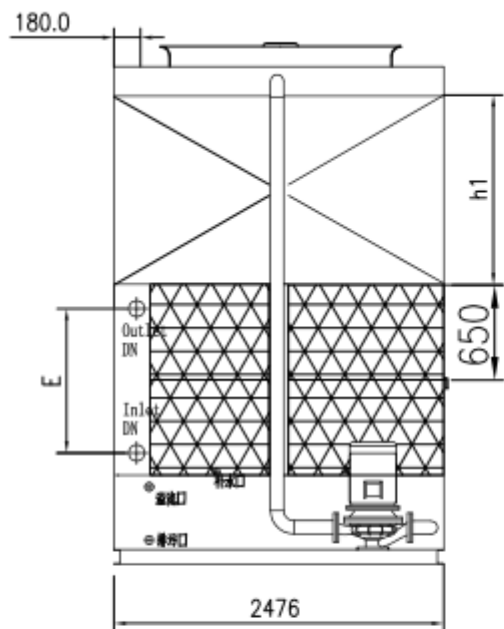

VIEW 2

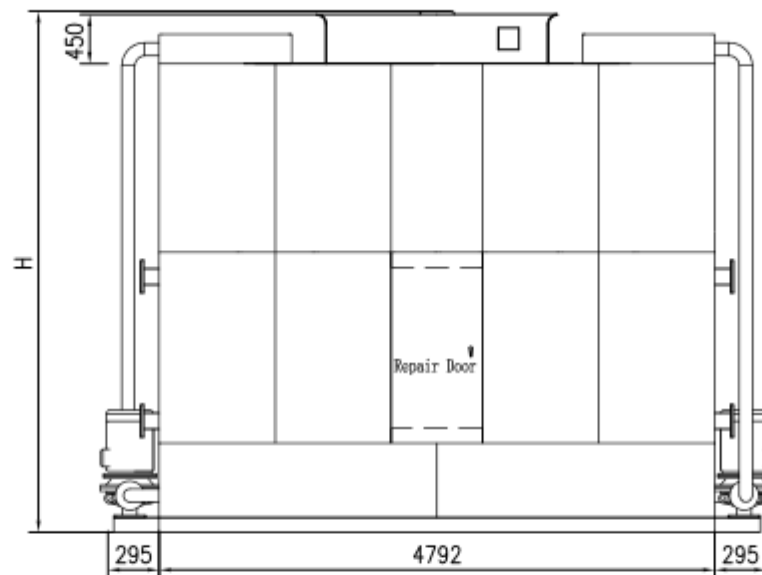

VIEW 1

型号	H	E	DN	h1
FBHL-361BD	3550	625	100x2	1300
FBHL-362BP	3550	865	100x2	1300
FBHL-362ED	4150	865	125x2	1300
FBHL-362EP	4150	865	125x2	1300
FBHL-363ED	4150	1105	125x2	1300
FBHL-363EP	4150	1105	125x2	1300
FBHL-363HP	4980	1105	125x2	1720
FBHL-363HG	4980	1105	125x2	1720
FBHL-364HP	4980	1345	125x2	1720
FBHL-364HG	4980	1345	125x2	1720

11) Model RCD-38X

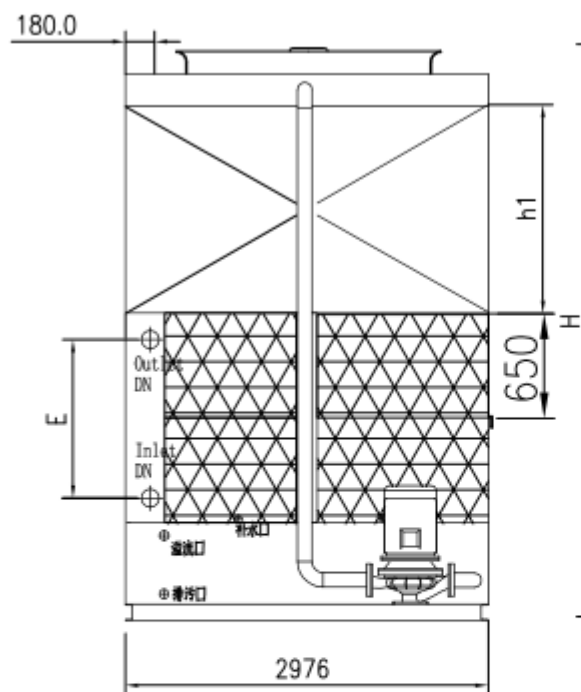

VIEW 2

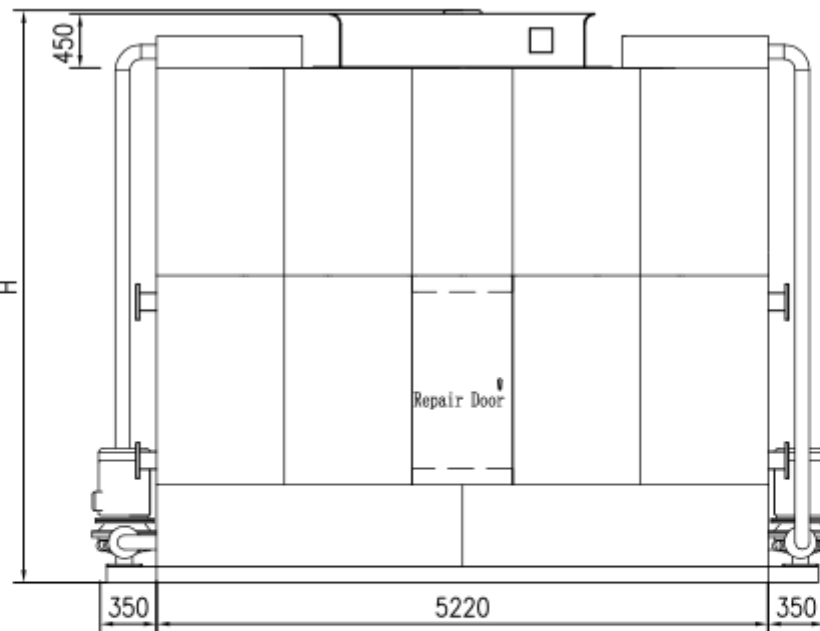

VIEW 1

型号	H	E	DN	h1
FBHL-381BD	3550	625	125x2	1300
FBHL-382BP	3550	865	125x2	1300
FBHL-382ED	4150	865	125x2	1300
FBHL-382EP	4150	865	125x2	1300
FBHL-383ED	4150	1105	125x2	1300
FBHL-383EP	4150	1105	125x2	1300
FBHL-383HP	4980	1105	125x2	1720
FBHL-383HG	4980	1105	125x2	1720
FBHL-384HD	4980	1345	125x2	1720
FBHL-384HP	4980	1345	125x2	1720
FBHL-384HG	4980	1345	125x2	1720

12) Model RCD-39X

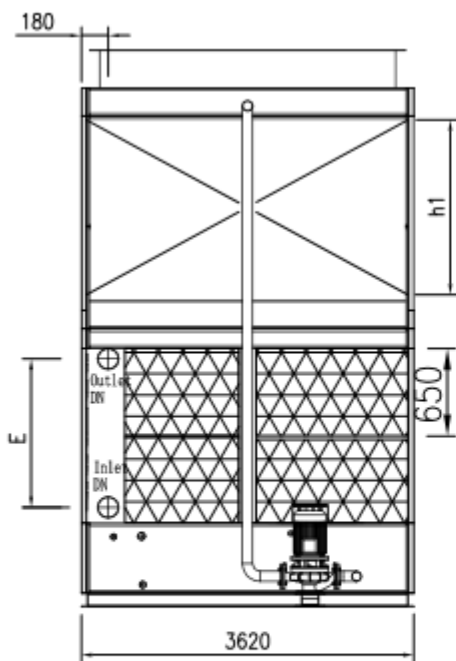

VIEW 2

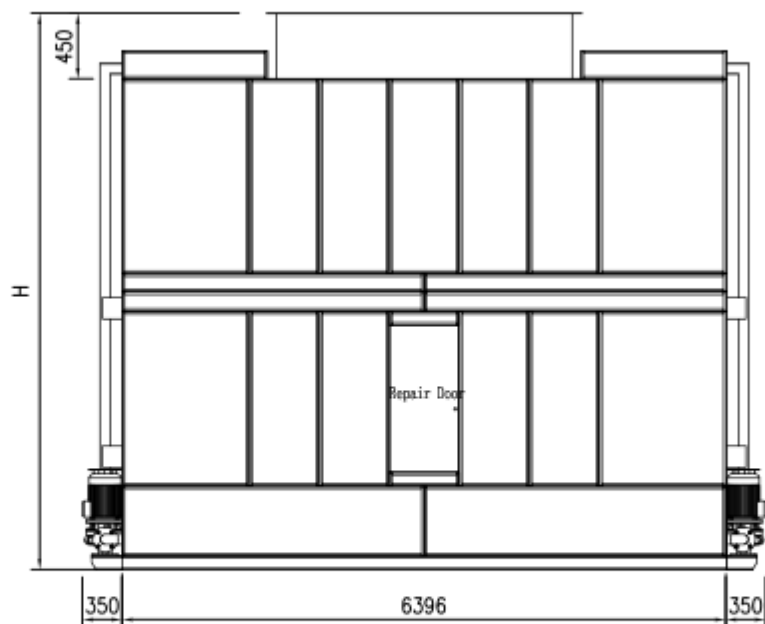

VIEW 1

型号	H	E	DN	h1
FBHL-393ED	4150	1105	150x2	1300
FBHL-393EP	4150	1105	150x2	1300
FBHL-393EG	4150	1105	150x2	1300
FBHL-393HD	4980	1105	150x2	1720
FBHL-393HP	4980	1105	150x2	1720
FBHL-393HG	4980	1105	150x2	1720
FBHL-394HD	4980	1345	150x2	1720
FBHL-394HP	4980	1345	150x2	1720
FBHL-394HG	4980	1345	150x2	1720

13) Model RCD-41X

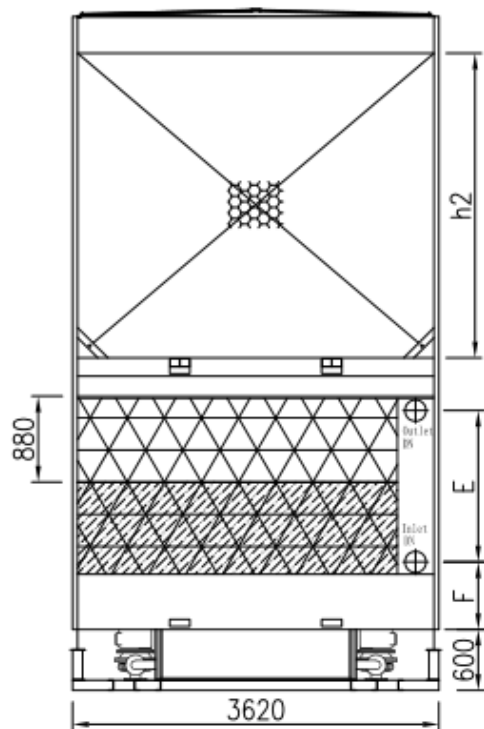

VIEW 2

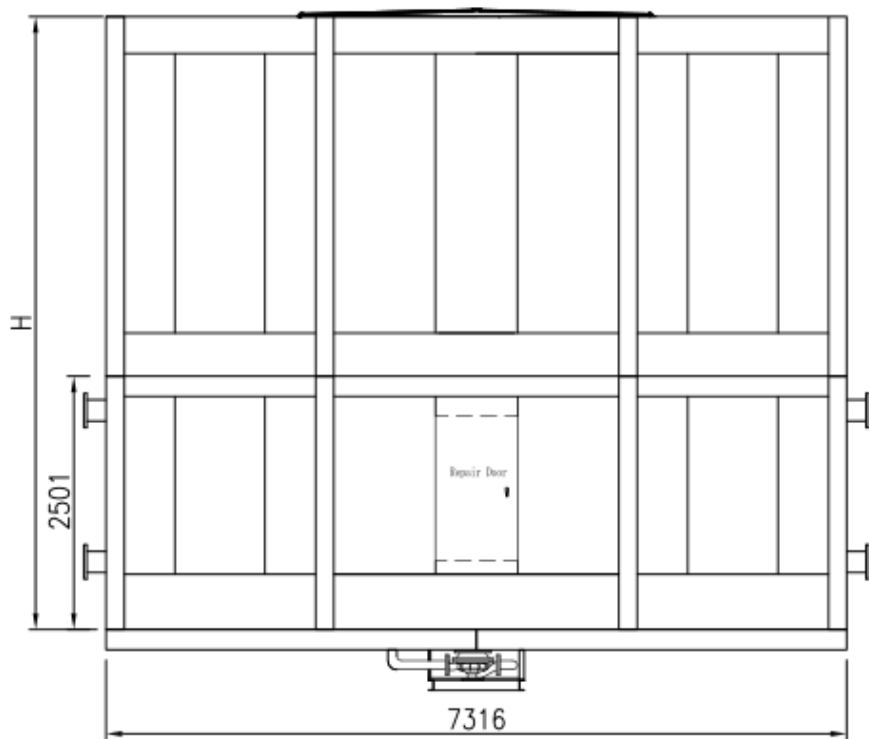

VIEW 1

型号	H	E	F	DN	h2
FBHL-413ED	5020	1235	797	150x2	1974
FBHL-413EL	5020	1235	797	150x2	1974
FBHL-413EP	5020	1235	797	150x2	1974
FBHL-413EG	5020	1235	797	150x2	1974
FBHL-413HD	6050	1235	797	200x2	3004
FBHL-413HL	6050	1235	797	200x2	3004
FBHL-413HP	6050	1235	797	200x2	3004
FBHL-413HG	6050	1235	797	200x2	3004
FBHL-414HD	6050	1495	667	200x2	3004
FBHL-414HL	6050	1495	667	200x2	3004
FBHL-414HP	6050	1495	667	200x2	3004
FBHL-414HG	6050	1495	667	200x2	3004

14) Model RCD-43X

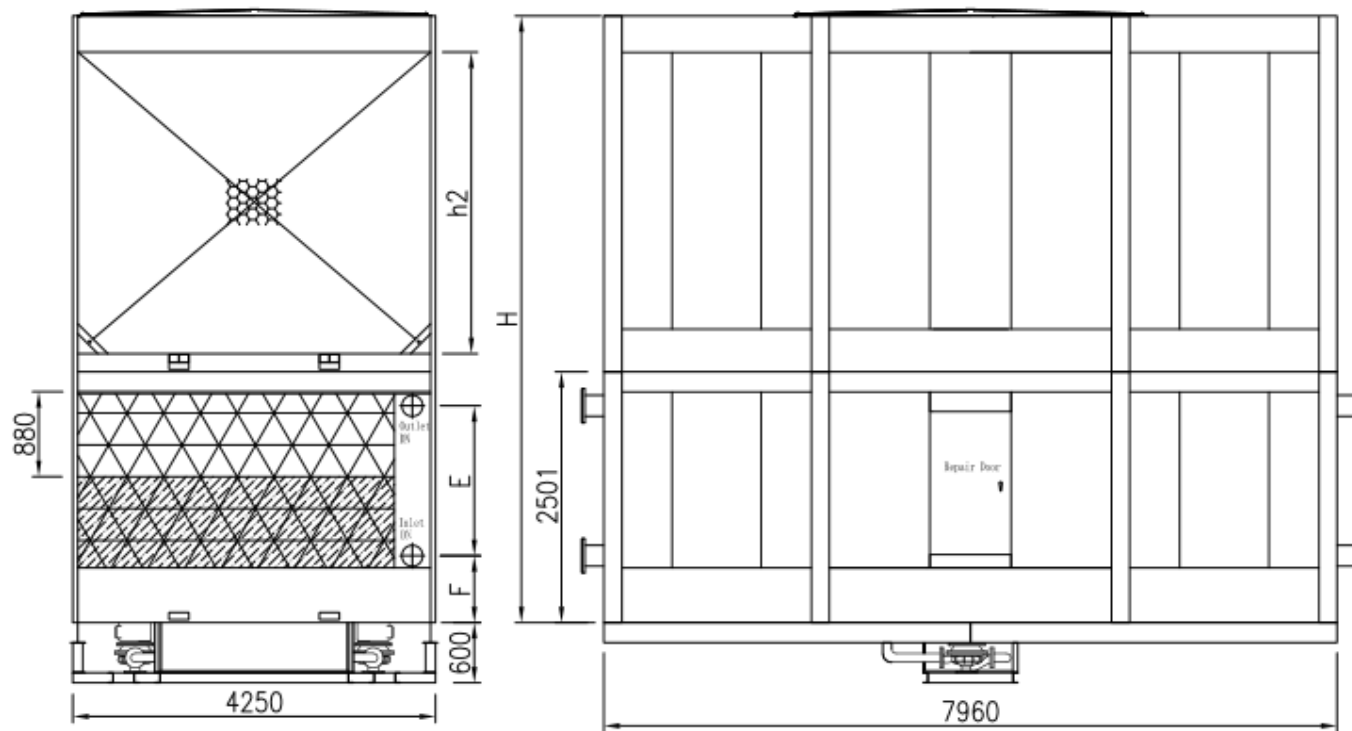

VIEW 2

VIEW 1

型号	H	E	F	DN	h2
FBHL-433ED	5020	1235	797	150x2	1974
FBHL-433EL	5020	1235	797	150x2	1974
FBHL-433EP	5020	1235	797	150x2	1974
FBHL-433EG	5020	1235	797	150x2	1974
FBHL-433HD	6050	1235	797	200x2	3004
FBHL-433HL	6050	1235	797	200x2	3004
FBHL-433HP	6050	1235	797	200x2	3004
FBHL-433HG	6050	1235	797	200x2	3004
FBHL-434HD	6050	1495	667	200x2	3004
FBHL-434HL	6050	1495	667	200x2	3004
FBHL-434HP	6050	1495	667	200x2	3004
FBHL-434HG	6050	1495	667	200x2	3004